



浙江中顺洁具有限公司

ZHEJIANG NESSATI PLUMBING LTD

E-mail: lin@nessati.com

Tel/WhatsApp: +86 188 6894 9208

Website: www.nessati.com

Factory Address: 58# Xixiaozhi Rd, Ningbo, Zhejiang, P.R.China

Office: Room 508 Bolang Mansion 1156# Heqing North Rd, Yinzhou District, Ningbo, Zhejiang, P.R. China



**ZHEJIANG NESSATI
PLUMBING LTD**





**ZHEJIANG NESSATI
PLUMBING LTD**

ACERO INOXIDABLE 304



F-3001 F-3002 F-3003 F-3004 F-3005 F-3006



F-3007 F-3008 F-3009 F-3010 F-3011 F-3012



F-3013 F-3014 F-3015 F-3016 F-3017 F-3018



F-3019 F-3020 F-3021 F-3022 F-3023 F-3024



F-3025 F-3026 F-3027 F-3028 F-3029 F-3030

ACERO INOXIDABLE 304



F-3031 F-3032 F-3033 F-3034 F-3035 F-3036



F-3037 F-3038 F-3039 F-3040 F-3041 F-3042



F-3043 F-3044 F-3045 F-3046 F-3047 F-3048



F-3049 F-3050 F-3051 F-3052 F-3053 F-3054



F-3055 F-3056 F-3057 F-3058 F-3059 F-3060

ACERO INOXIDABLE 304



ACERO INOXIDABLE 304

SOLO AGUA FRIA



ACERO INOXIDABLE 304



F-3201 F-3202 F-3203 F-3204 F-3205 F-3206



F-3207 F-3208 F-3209 F-3210 F-3211 F-3212



F-3213 F-3214 F-3215 F-3216 F-3217 F-3218



F-3219 F-3220 F-3221 F-3222 F-3223 F-3224



F-3225 F-3226 F-3227 F-3228 F-3229 F-3230

ACERO INOXIDABLE 304



F-3231 F-3232 F-3233 F-3234 F-3235 F-3236



F-3237 F-3238 F-3239 F-3240 F-3241



F-3242 F-3243 F-3244 F-3245 F-3246 F-3247



F-3248 F-3249 F-3250 F-3251

ACERO INOXIDABLE 304

ACERO INOXIDABLE 304



F-3301



F-3302



F-3303



F-3304

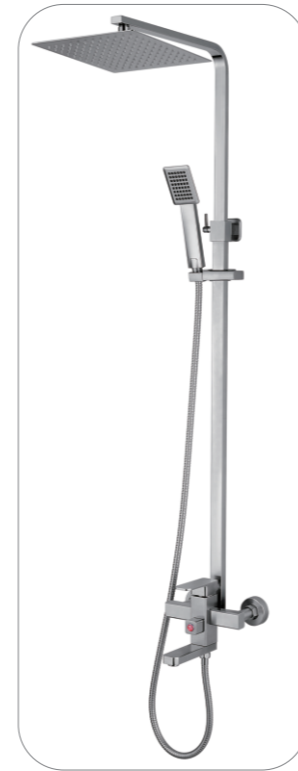

F-3309



F-3310

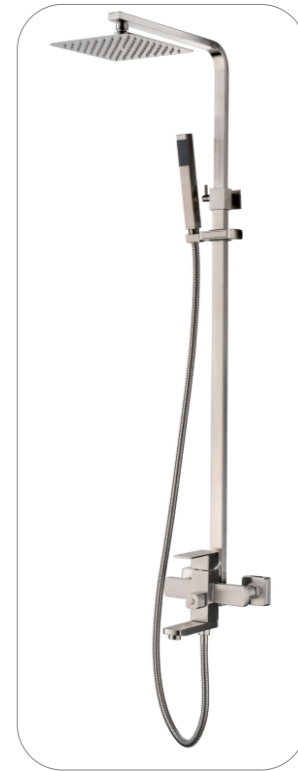

F-3311



F-3312

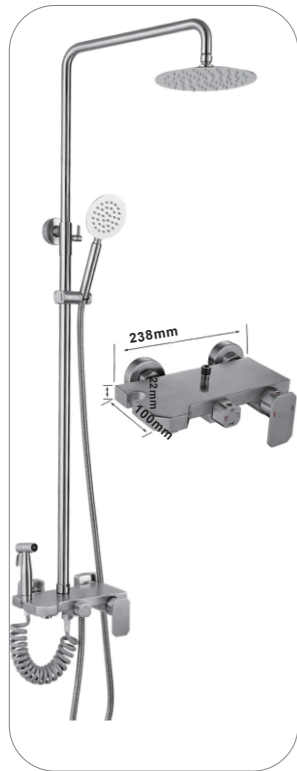

F-3305



F-3306



F-3307



F-3308

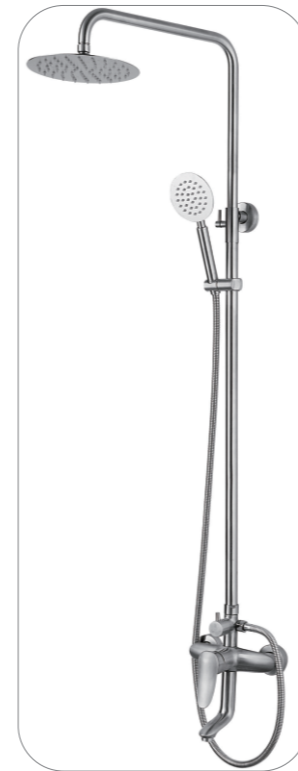

F-3313



F-3314



F-3315



F-3316

ACERO INOXIDABLE 304

ACERO INOXIDABLE 304



F-3317



F-3318



F-3319



F-3320



F-3325



F-3326



F-3327



F-3321



F-3322



F-3323



F-3324

ACERO INOXIDABLE 304



F-3332



F-3333



F-3334



F-3335

ACERO INOXIDABLE 304



F-3353



F-3354



F-3355



F-3356



F-3357



F-3336



F-3337



F-3338



F-3339



F-3340



F-3341



F-3342



F-3343



F-3344



F-3345



F-3346



F-3347



F-3348



F-3349



F-3350



F-3351



F-3352



F-3358



F-3359



F-7001 F-7002 F-7003 F-7004 F-7005 F-7006



F-7007 F-7008 F-7009 F-7010 F-7011 F-7012



F-7013 F-7014 F-7015 F-7016 F-7017 F-7018



F-7019 F-7020





F-3501



F-3502



F-3503

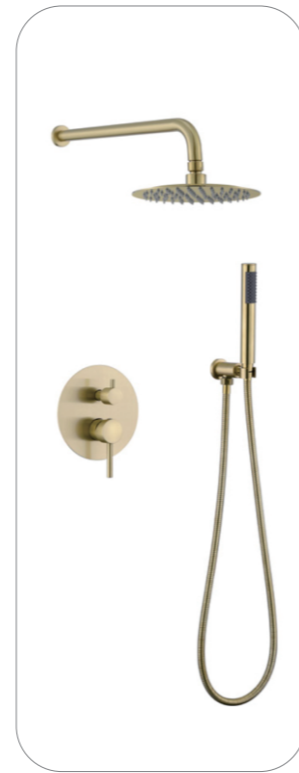

F-3504



F-3509



F-3510



F-3511

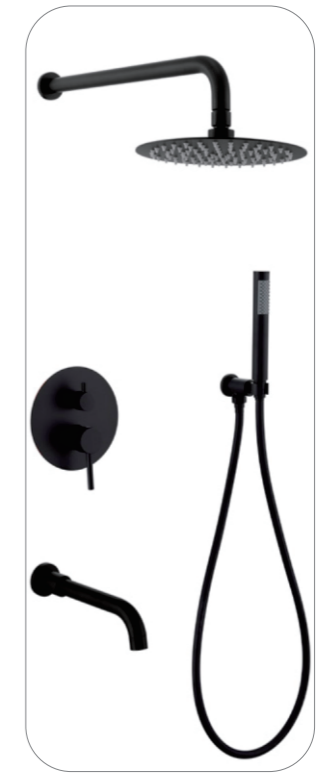

F-3512



F-3505

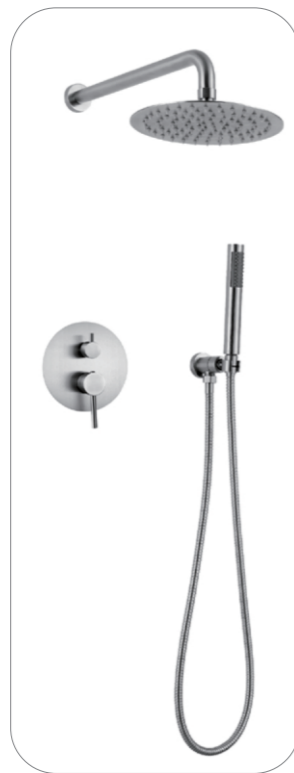

F-3506



F-3507



F-3508



F-3513



F-3514



F-3515

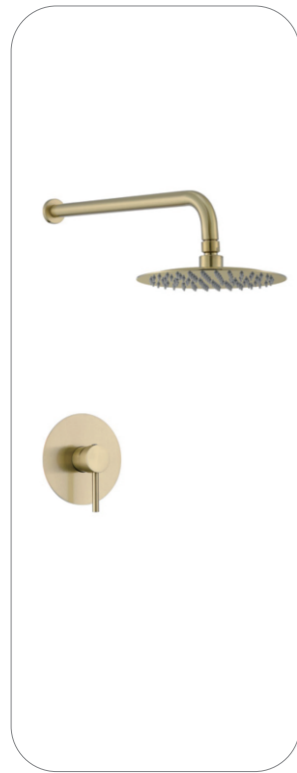

F-3516



F-3517



F-3518



F-3519



F-3522



F-3523



F-3524



F-3525

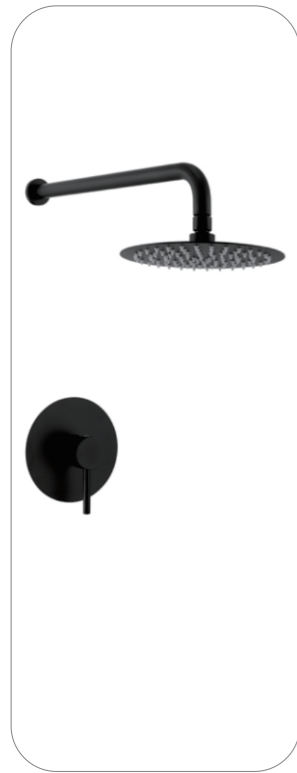

F-3520



F-3521



F-3526



F-3527



F-3528



F-3529



F-3530



F-3531

ACERO INOXIDABLE 304



F-3401 F-3402 F-3403 F-3404 F-3405 F-3406



F-3407 F-3408 F-3409 F-3422

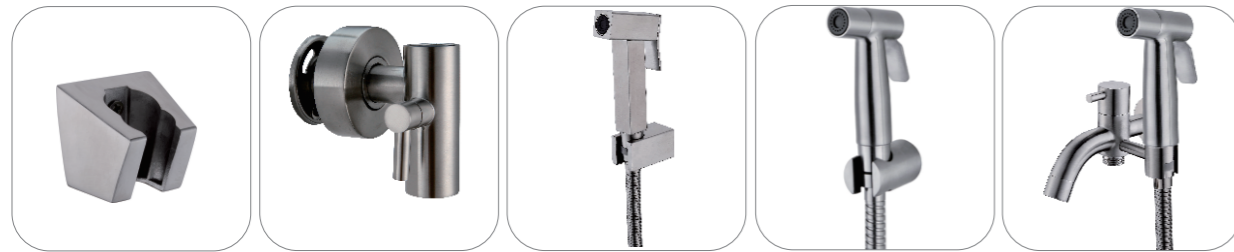

F-3410 F-3411 F-3412 F-3413 F-3414

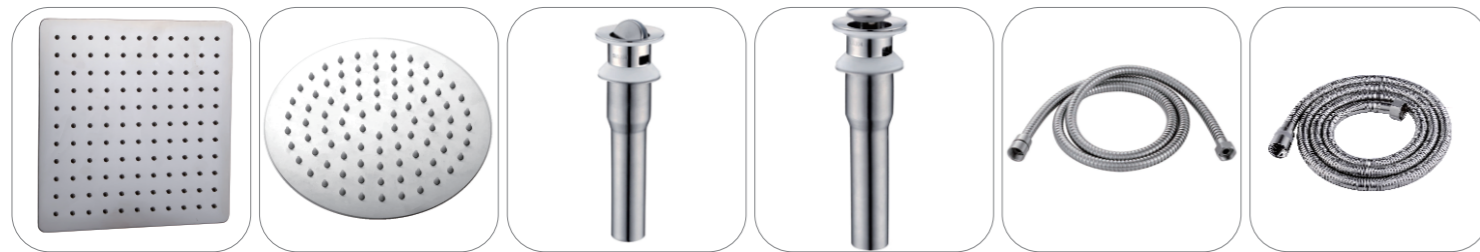

F-3415 F-3416 F-3417 F-3418 F-3419 F-3420



F-3421

ACERO INOXIDABLE 304

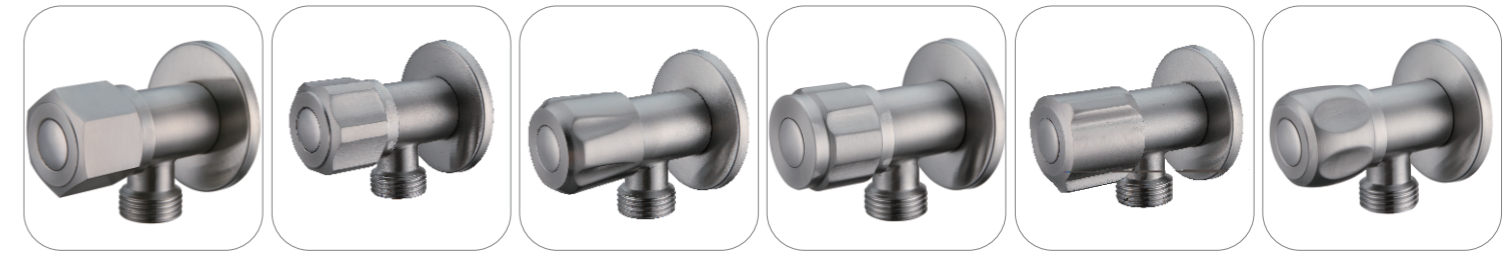

F-3501 F-3502 F-3503 F-3504 F-3505 F-3506

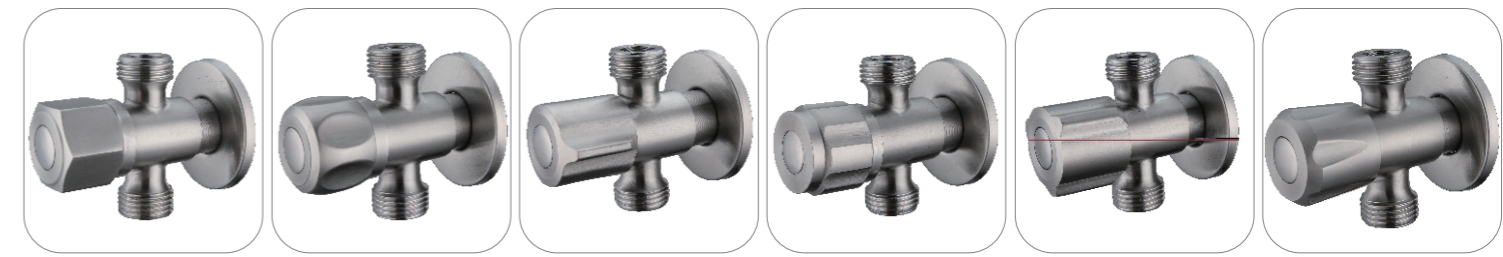

F-3507 F-3508 F-3509 F-3510 F-3511 F-3512



F-3513 F-3514 F-3515 F-3516 F-3517 F-3518



F-3519 F-3520 F-3521 F-3522 F-3523 F-3524



F-3525 F-3526 F-3527



S-4001 MT 0390 S-4002 S-4105 S-4106 S-4107



S-4004 S-4040 S-4066 S-4027 S-4028 MT 0385

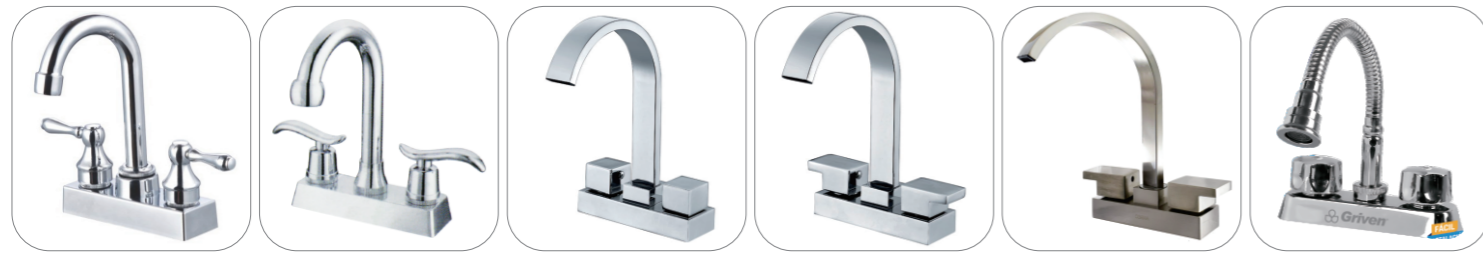

S-4108 S-4073 S-4109 S-4110 S-4111 S-4112



S-4113 S-4007 S-4072 S-4008 S-4005 S-4080



S-4114 S-4094 S-4053 S-4115



S-4014 S-4032 S-4013 S-4082 S-4009 S-4011



S-4043 S-4010 S-4103 MT 0391 S-4102



S-4062 S-4039 S-4037 S-4038 S-4081 S-4067



S-4025 S-4029 S-4026 S-4003 S-4064 S-4017



S-4022 S-4015 S-4018 S-4021 S-4016 S-4023



S-4116 S-4117 S-4006 S-4035 MT 0396 S-4020



S-4086 S-4091 S-4088 S-4089 S-4119 S-4120



S-4121 S-4122 S-4076 S-4090 S-4049 S-4123



S-4050 S-4124 S-4125 S-4126 S-4087 S-4127



S-4092 S-4075 S-4077 S-4128 MT 0388 S-4129



S-4130 S-4131 S-4083 S-4084 S-4132 S-4052



S-4133 S-4134 S-4135 S-4136 S-4137 S-4138



S-4068 S-4071 S-4056 S-4139 S-4059 S-4095



S-4140 S-4041 S-4042



S-4061 S-4078 S-4079 S-4141 S-4142 S-4051



S-4063 S-4065 S-4074 S-4143



S-4100 S-4104 MT 0392 S-4057 S-4069 S-4031



S-4099 S-4096 S-4044 S-4047 S-4030



S-4033 S-4093 S-4098 S-4145 S-4146 S-4147



S-4148 S-4149 S-4150 S-4019 S-4151 S-4152



S-4153 S-4058 S-4154 S-4060 S-4085 S-4012



S-4024 S-4155 S-4055 S-4054 S-4097 S-4070



S-4157 S-4158



S-4159 S-4160 S-4161 S-4048 S-4034 S-4162



S-4163 S-4164 S-4036 S-4045 S-4046



S-8087 S-8084 S-8009 S-8006 S-8005



S-8082 S-8104 S-8105 S-8033 S-8052



S-8071 S-8012 S-8065 S-8011 S-8020



S-8010 S-8032 S-8035 S-8062 S-8063



S-8007 S-8106 S-8064 S-8039 S-8107



S-8025 S-8026 S-8004 S-8108 S-8109



S-8110 S-8111 S-8112 S-8113 S-8053



S-8066 S-8114 S-8048 S-8115 S-8069



S-8116 S-8118 S-8079 S-8119 S-8036



S-8051 S-8013 S-8027 S-8002 S-8120



S-8003



S-8121



S-8122



S-8123



S-8124



S-8057



S-8125



S-8126



S-8127



S-8049



S-8022



S-8034



S-8072



S-8016



S-8014



S-8008



S-8017



S-8024



S-8015



S-8032



S-8037



S-8060



S-8065



S-8128



S-8021



S-8018



S-8019



S-8070



S-8129



S-8130



S-8131



S-8041



S-8042



S-8040



S-8045



S-8043



S-8044



S-8132



S-8133



S-8077



S-8134



S-8102



S-8135



S-8050



S-8075



S-8068



S-8055 S-8054 S-8136 S-8103 S-8028



S-8058 S-8059 S-8146 S-8147 S-8148



S-8137 S-8138 S-8139 S-8140 S-8141



S-8149 S-8150 S-8151 S-8152 S-8153



S-8142 S-8046 S-8073 S-8023 S-8143



S-8154 S-8155 S-8156 S-8157 S-8047



S-8144 S-8145 S-8031 S-8056 S-8061



S-8158 S-8159 S-8160 S-8081 S-8161



S-8067 S-8029 S-8076 S-8078 S-8074



S-8085 S-8162 S-8163 S-8164



S-5001

S-5003

S-5002

S-5004



S-5005

S-5006

S-5007

S-5014



S-5015

S-5016

S-5008

S-5009



S-5010

S-5011

S-5012

S-5013





S-8088



S-8201



S-8092



S-8209



S-8094



S-8095



S-8098



S-8097



S-8091



S-8210



S-8202



S-8203



S-8100



S-8096



S-8207



S-8208



S-8089



S-8093



S-8204



S-8205



S-8099



S-8206



S-8090

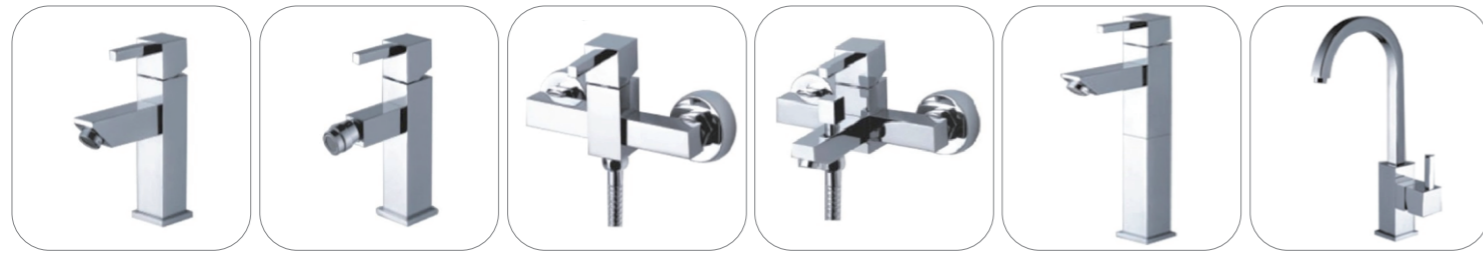

E-6011 E-6012 E-6013 E-6014 E-6015 E-6016



E-6021 E-6022 E-6023 E-6024 E-6025 E-6026

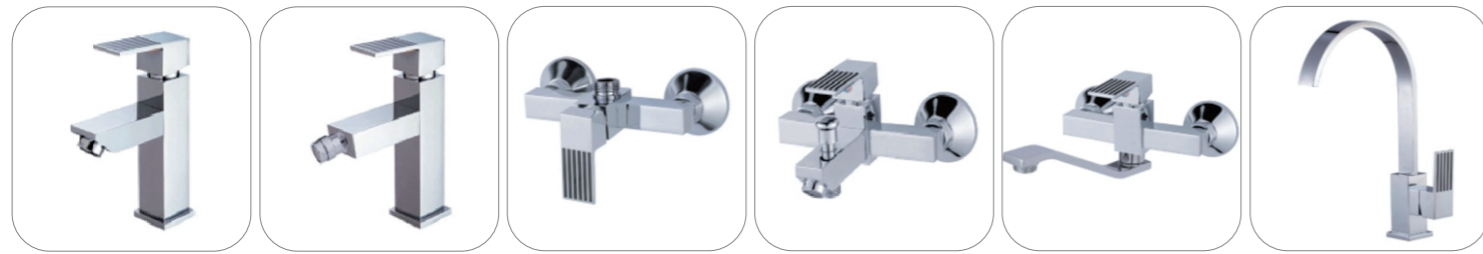

E-6031 E-6032 E-6033 E-6034 E-6035 E-6036

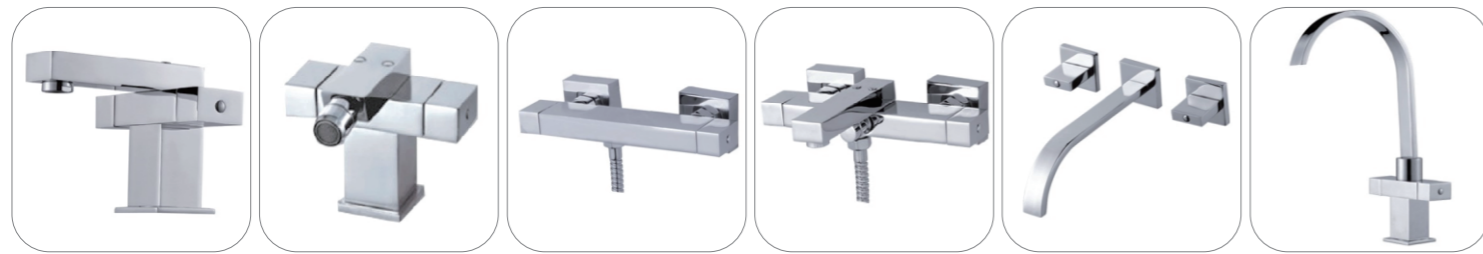

E-6041 E-6042 E-6043 E-6044 E-6045 E-6046



E-6051 E-6052 E-6053 E-6054 E-6055 E-6056



E-6061 E-6062 E-6063 E-6064 E-6065 E-6066

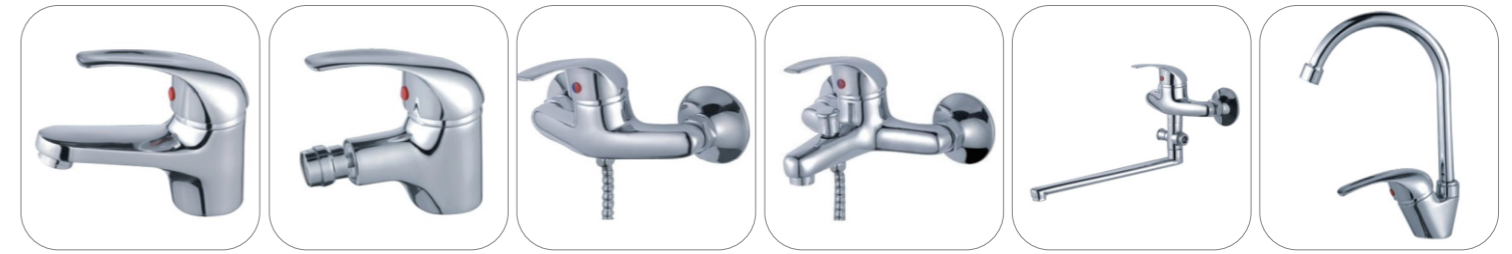

E-6071 E-6072 E-6073 E-6074 E-6075 E-6076



E-6081 E-6082 E-6083 E-6084 E-6085



E-6201 E-6202 E-6203 E-6204



E-6101 E-6102 E-6103 E-6104 E-6105 E-6106

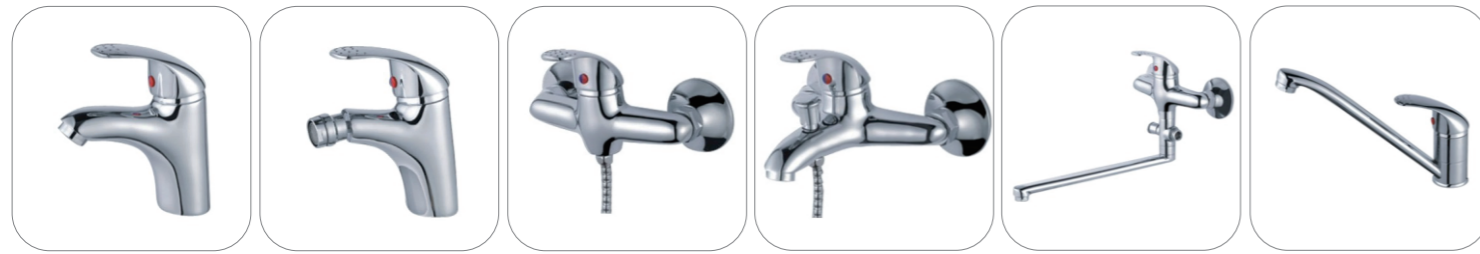

E-6111 E-6112 E-6113 E-6114 E-6115 E-6116



E-6211 E-6212 E-6213 E-6214 E-6215 E-6216

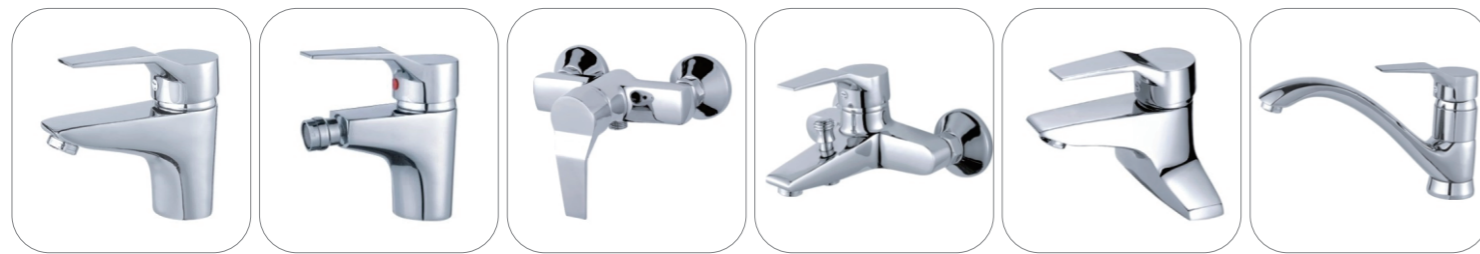

E-6131 E-6132 E-6133 E-6134 E-6135 E-6136

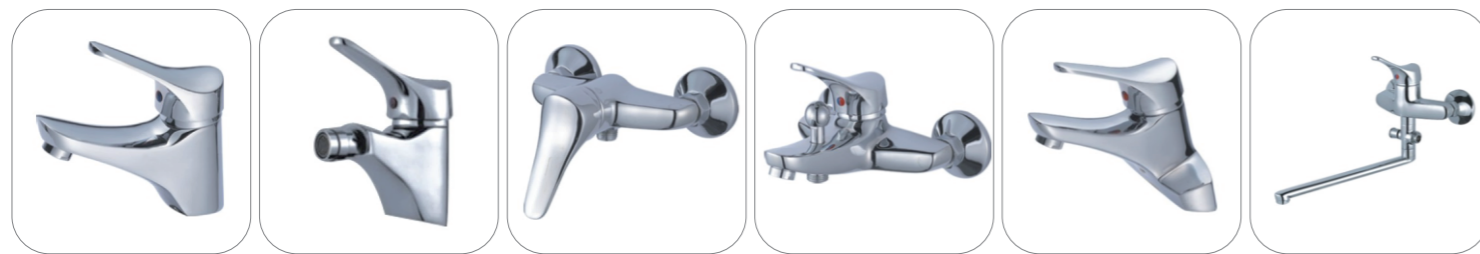

E-6141 E-6142 E-6143 E-6144 E-6145 E-6146



E-6161 E-6162 E-6163 E-6164 E-6165 E-6166



E-6171 E-6172 E-6173 E-6174 E-6175 E-6176



E-6181 E-6182 E-6183 E-6184 E-6185 E-6186



E-6191 E-6192 E-6193 E-6194 E-6195 E-6196



E-7001 E-7002 E-7003 E-7004 E-7005 E-7006



E-7007 E-7008 E-7009 E-7010 E-7011 E-7012



E-7013 E-7014 E-7015 E-7016 E-7017 E-7018



E-7019 E-7020 E-7021 E-7022 E-7023 E-7024

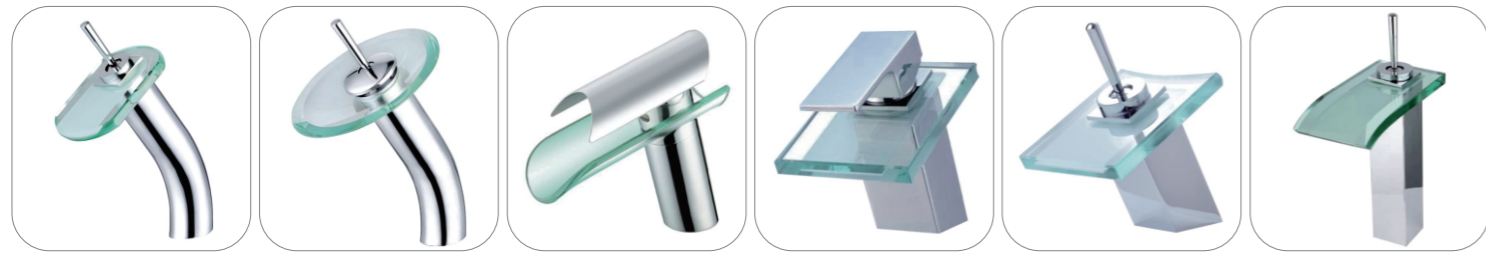

E-7025 E-7026 E-7027 E-7028 E-7029 E-7030



E-7036 E-7031 E-7032 E-7033 E-7034 E-7035



E-8001 E-8002 E-8003 E-8004 E-8005 E-8006



E-8007 E-8008 E-8009 E-8010 E-8011 E-8012



E-8013 E-8014 E-8015 E-8016 E-8017 E-8018



E-8019 E-8020 E-8021 E-8022



E-8030 E-8031 E-8032 E-8033 E-8034 E-8035



E-5001 E-5002 E-5003 E-5004 E-5005 E-5006



E-5007 E-5010 E-5011 E-5012 E-5013



E-9105 E-9106 E-9107 E-9108 E-9109



E-9201 E-9202 E-9203 E-9204 E-9205



E-9301 E-9102 E-9303 E-9304 E-9305 E-9306



E-9001 E-9002 E-9003 E-9004 E-9005 E-9006



E-9307 E-9308 E-9309 E-9310 E-9104 E-9106



S-001 S-002 S-003 S-004 S-005 S-006



S-007 S-008 S-009 S-010 S-011 S-1001



S-1002 S-1003 S-1020 S-1004 S-1005 S-1006



S-1007 S-1008 S-1009 S-1010 S-1011 S-1012



S-1013 L-034 L-035 L-036 L-037 S-1019



S-1014 S-1015 S-1016 S-1017 S-1018 S-1021



L-041 L-042 L-043 L-046 S-1022 S-1023



S-1024 S-1029 S-1025 S-1026 S-1027 S-1028



S-1042 S-1043 S-1044 S-1045 S-1046 S-1047



S-1048 S-1034 S-1035 S-1036 S-1037 L-044



S-1030 S-1031 S-1032 S-1033 L-033 L-045



L-047 S-1038 S-1039 S-1040 S-1041 S-1078



L-039 L-040 L-048 L-049 L-050

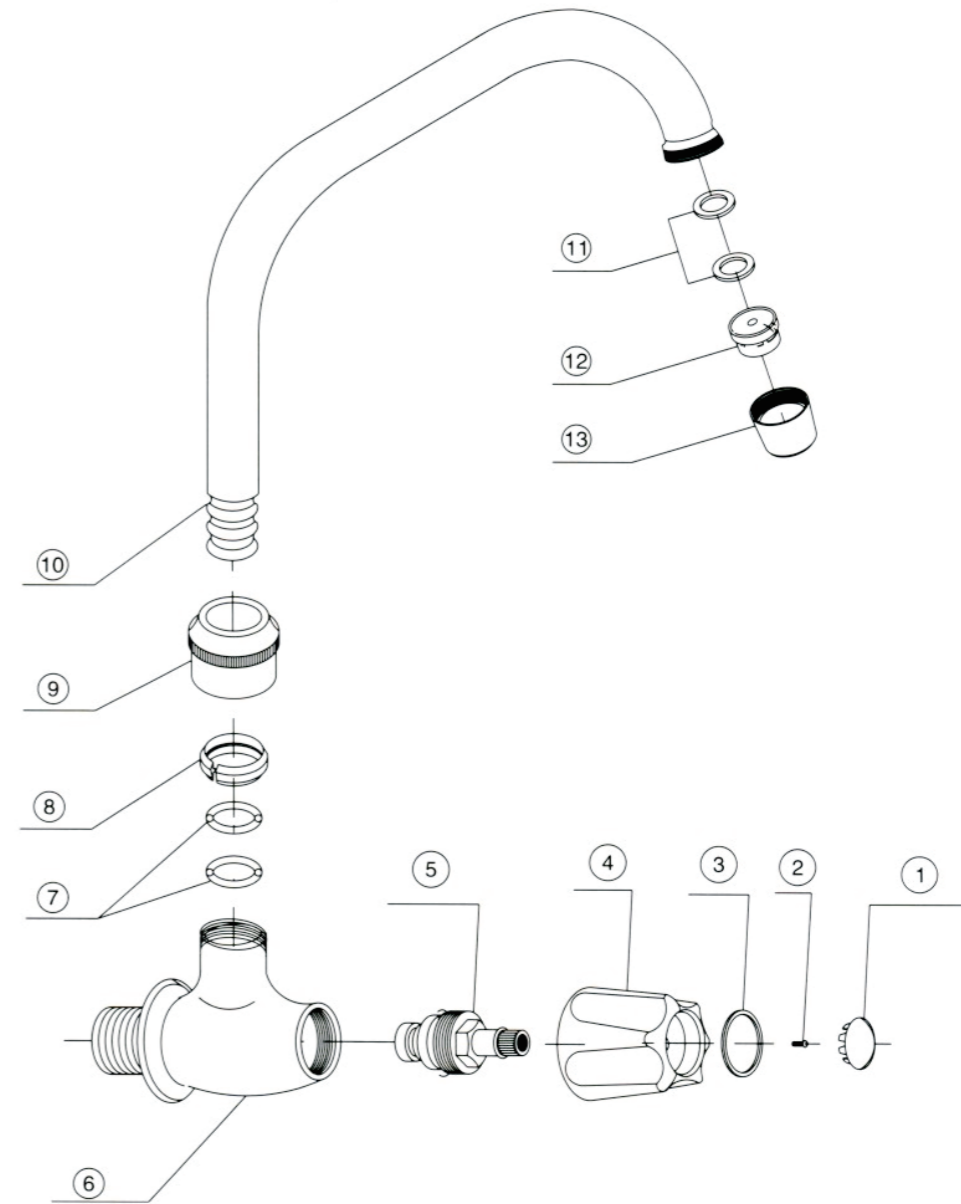



L-016 L-017 L-018 L-019 L-020 L-021



L-032 L-029 L-031 L-014 L-022 L-023



L-024 L-025 L-026 L-027 L-030 L-033



L-027A L-015 S-1083 S-1084 S-1085 L-028



S-1049 S-1070 S-1074 S-1086 L-027P S-1074B



S-1050 S-1051 S-1052 S-1053 S-1054 S-1075



S-1082 S-1087 S-1076 S-1077 S-1080 S-1081



S-1079





R-2209 R-2210 F-1516 F-1501 F-1514 F-1518



F-1517 F-1507 F-1508 F-1519 F-1510 F-1506

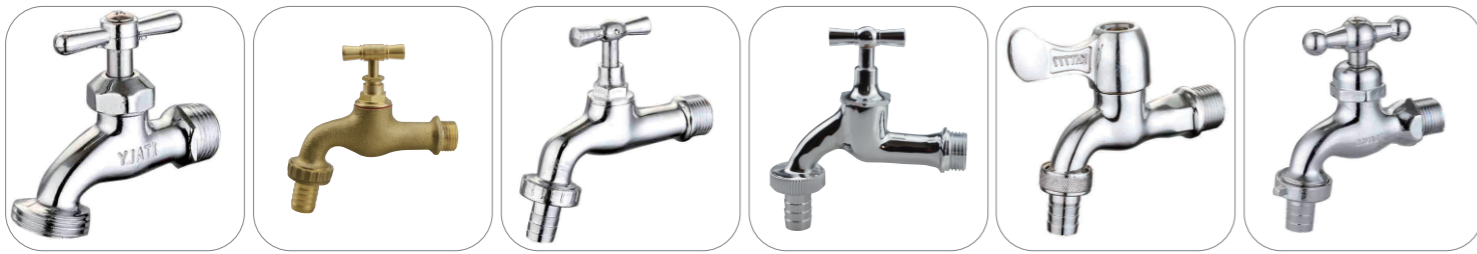

R-2206 R-2254 R-2201 R-2204 R-2226 R-2221



R-2100 R-2101 R-2102 R-2103 R-2107 R-2108



R-2110 R-2112 R-2115 R-2117 R-2223 R-2222



F-507 F-508 F-503 F-504 R-2233 S-1073



L-001 L-002 L-003 L-004 L-005 L-006



L-007 L-008 S-1055 S-1056 S-1057 S-1058



S-1059 S-1060 S-1061 S-1062 S-1063 S-1064



S-1065 S-1066 S-1067 S-1068 S-1069 S-1072

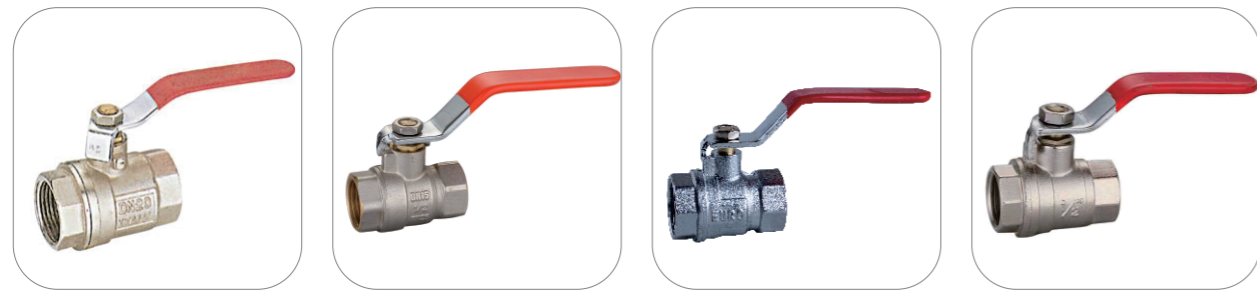

R-1101 R-1102 R-1103 R-1104



R-1107 F-2009 F-2010 F-2008



F-2019 F-2023 F-2025 F-2026



F-2018 F-2024 F-2016 F-2017



F-2022 F-2027 F-2028 F-2029



R-4101 R-4102 R-4103 R-4109 R-4111



R-4115 R-4601 R-6103 R-6105 R-6105C



R-6106 R-6106B R-6110 R-6117 R-6128



R-6612 R-6612B R-3101 R-3201 R-3301



R-3401 R-3402



F-5201 A:1/2"x3/8"x3/8" B:3/8"x3/8"x3/8" F-5218 1/2"x3/8"x3/8" F-5219 3/8"x3/8"x3/8" F-5202 A:1/2"x3/8" B:3/8"x3/8" F-5220 3/8"x1/2" F-5221 3/8"x3/8"

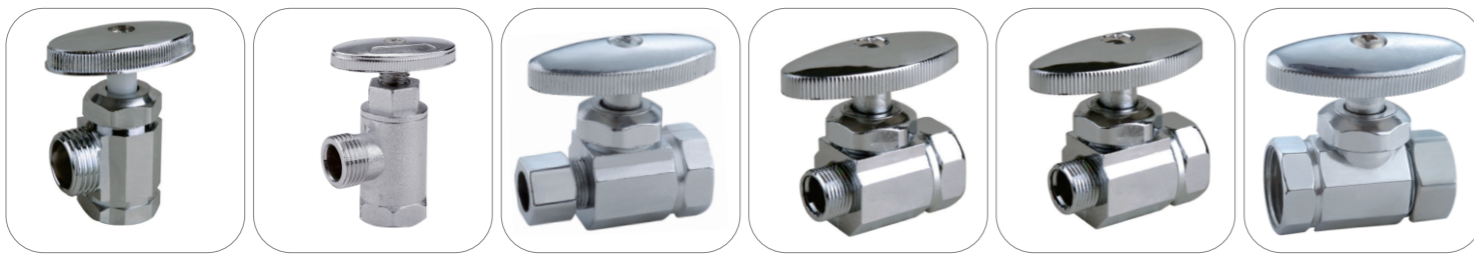

F-5208 1/2"x1/2" F-5210 F-5204 A:1/2"x3/8" B:3/8"x3/8" F-5222 3/8"x1/2" F-5223 3/8"x3/8" F-5209 1/2"x1/2"



F-5212 1/2"x3/8" F-5217 3/8"x3/8" F-5213 1/2"x1/2" F-5211 F-5217 F-5218



F-5214 F-5215 F-5216



S-3002 S-3004 S-3005 S-3006 S-3007 S-3008



S-3013 S-3011 S-3003 S-3012 S-3009 S-3010



F-2301 F-2302 F-2303 F-2304 F-2305 F-2306



F-2307 F-2308 F-2309



F-5102 F-5103 F-5104 F-5105 F-5101



F-1301 F-1305 F-1306 F-1308 F-1309 F-1310



F-1313 F-1314 F-1315 F-1316 F-1317 F-1320



F-1318 F-1319 F-1321 F-1322 F-1323 F-1324



F-1325 F-1326 F-1327 F-1328 F-1329 F-1330



F-1331 F-1332 F-1333 F-1336 MT 1509 MT 1509B



S-8301 S-8302 S-8303 S-8304

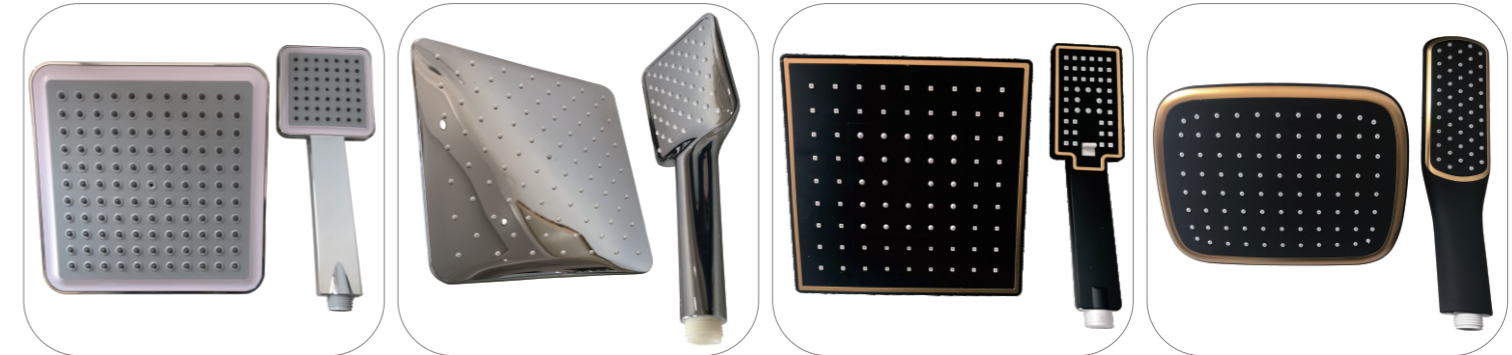

S-8305 S-8306 S-8307 S-8308



S-8309 S-8310 S-8311 S-8312



S-8313 S-8314 S-8315 S-8316



F-1337

F-1338

F-1339



S-8329

S-8330

S-8331

S-8332



S-8317

S-8318

S-8319

S-8320



S-8333

S-8334

S-8335

S-8336



S-8321

S-8322

S-8323

S-8324



S-8337

S-8338

S-8339

S-8340



S-8325

S-8326

S-8327

S-8328



S-8341

S-8342

S-8343

S-8344



F-1341 F-1342 F-1343 F-1344 F-1345 F-1346

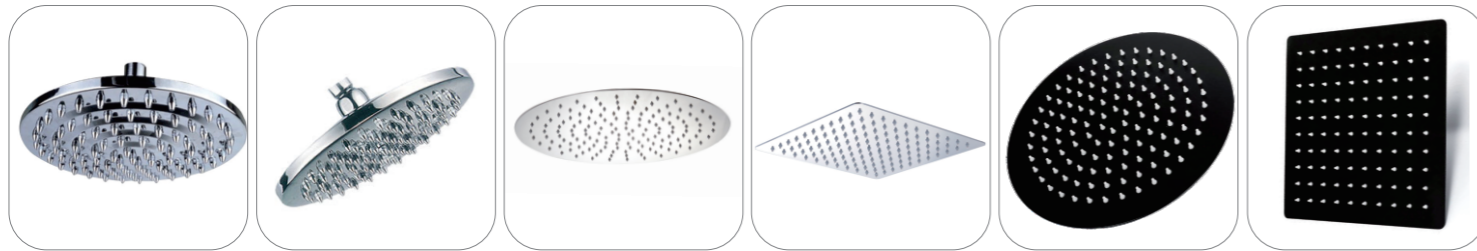

F-1340 F-1348 MT 1563 MT 1562 MT 1565 MT 1566



F-1349 F-1350 F-1351 F-1352 F-1353 F-1354



F-1355 F-1356 F-1357 F-1358 F-1359 F-1360

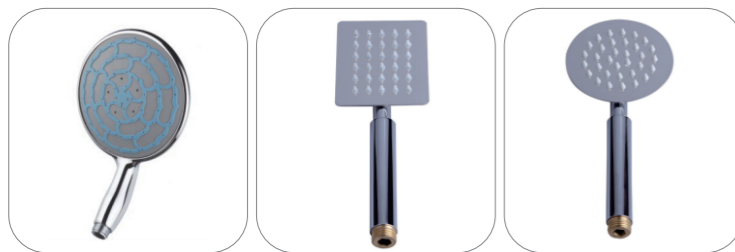

F-1362 F-1375 F-1376



F-1367 F-1368 F-1369 F-1370 F-1371 F-1372



F-1373 F-1374



F-1601 F-1602 F-1603 F-1604 F-1605 F-1636



F-1606 F-1607 F-1608 F-1609 F-1610 F-1611



F-1612 F-1613 MT0280 F-1614 F-1615



F-1618 F-1619 F-1623 F-1624 F-1621 F-1622



F-1625 F-1626 F-1627 F-1628 F-1629 F-1630

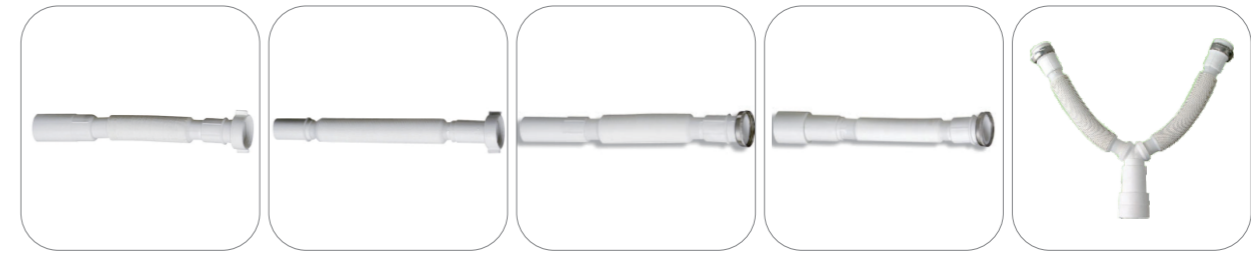

F-1631 1 1/2 F-1632 1 1/4 F-1633 F-1634 F-1635



MT0283 MT0284 MT0285



F-1820 F-1908 MT 0286 MT 0261 F-1818 F-1819

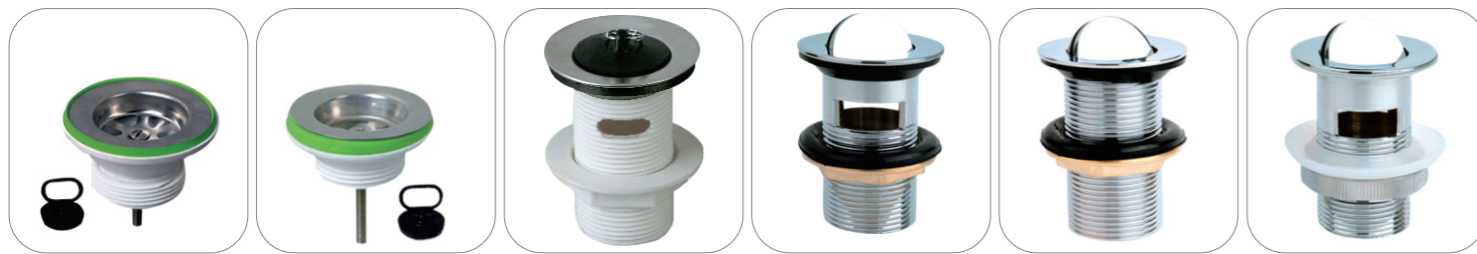

F-1905 F-1906 F-1821 F-1822 F-1823 F-1824



F-1825 F-1826 F-1827 F-1828 F-1829 F-1830

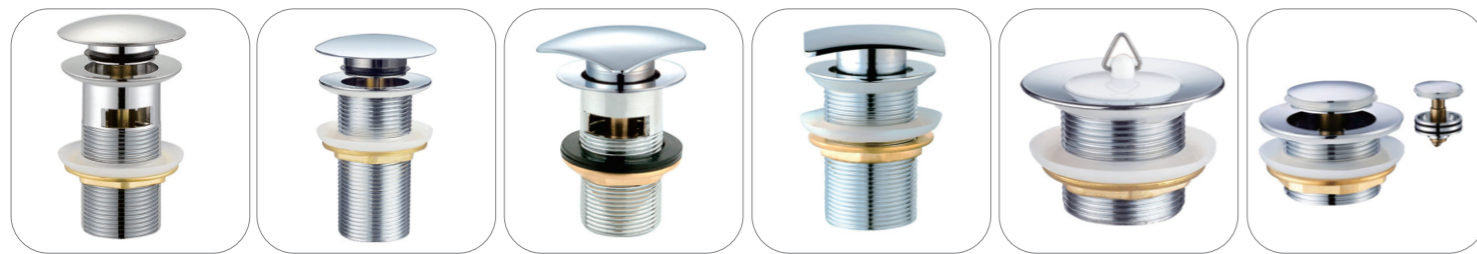

F-1831 F-1832 F-1833 F-1834 F-1835 F-1836



F-1837 F-1838 F-1839 F-1840 F-1841

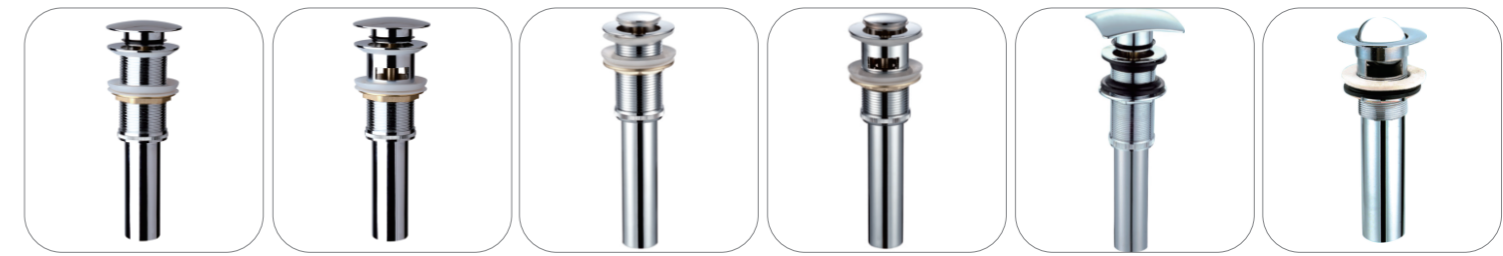

F-1801 F-1843 F-1807 F-1842 F-1808 F-1803

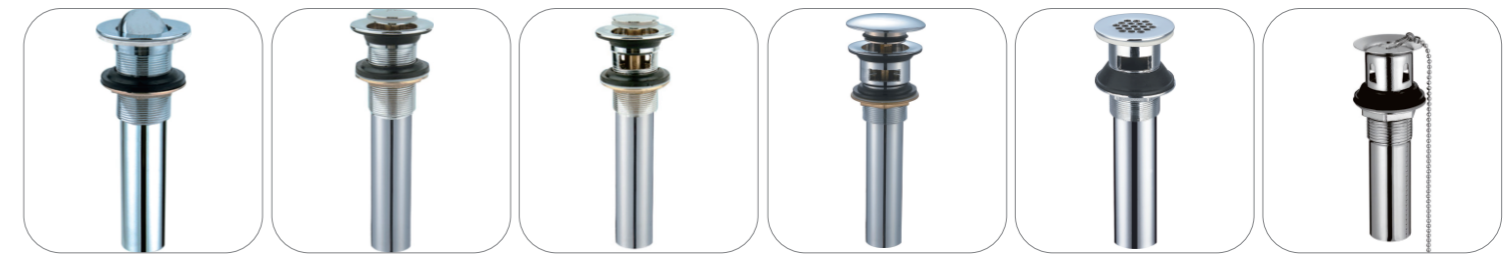

F-1804 F-1806 F-1844 F-1809 F-1802 F-1810



F-1813 F-1811 F-1814 F-1816 F-1817 F-1815



F-1901 F-1902 F-1903 F-1904 F-1907 F-1912



F-1913 F-1914 F-1915 F-1916 F-1911



F-1701 F-1702 F-1703 F-1704 F-1705 F-1706

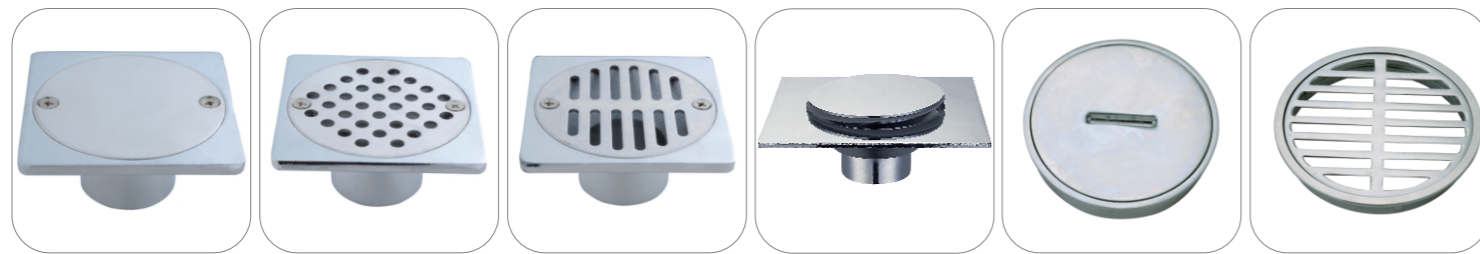

F-1710 F-1711 F-1712 F-1731 F-1713 F-1716



F-1719 F-1720 F-1721 F-1722 F-1723 F-1724

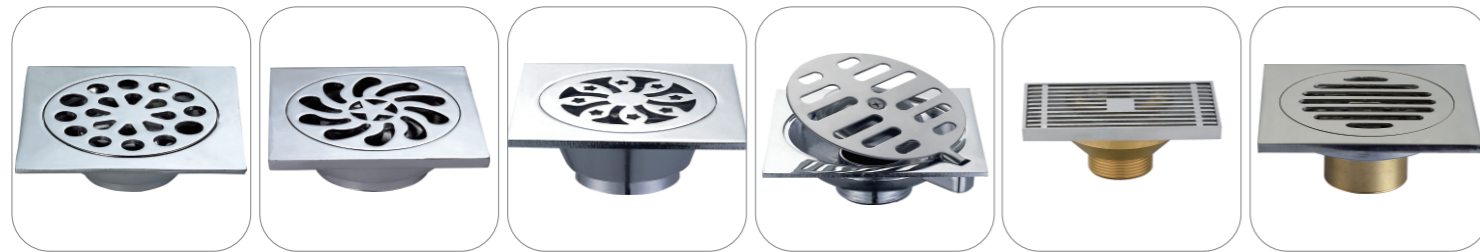

F-1725 F-1726 F-1727 F-1728 F-1729 F-1730



F-1732 F-1733 F-1734 F-1735 F-1736 F-1718

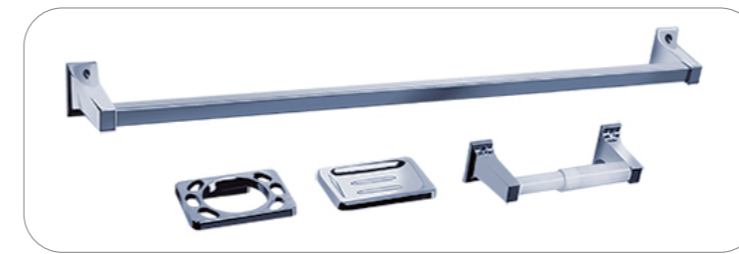

F-2601



F-2602



F-2615

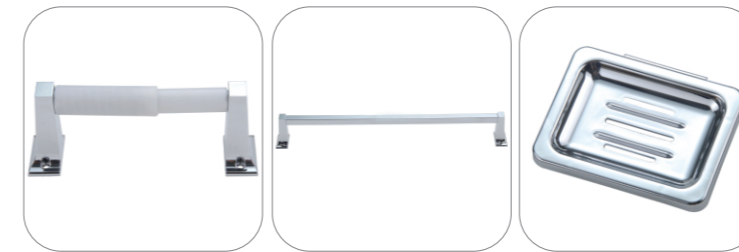

F-2603 F-2604 F-2605



F-2606 F-2609 F-2608



F-2450



F-2451



F-2452



F-2453

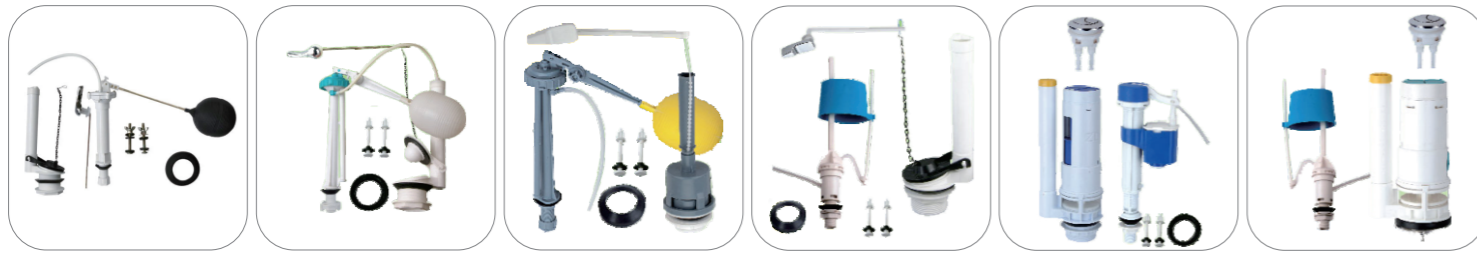

F-2401 F-2402 F-2403 F-2404 F-2405 F-2406



F-2407 F-2408 F-2408B F-2409 F-2412 F-2460



F-2410 F-2461 F-2411 F-2462 F-2414 F-2415



F-2416 F-2419 F-2423 F-2420 F-2420A F-2422



F-2424 F-2425 F-2426 F-2427 MT 0156 MT 0157

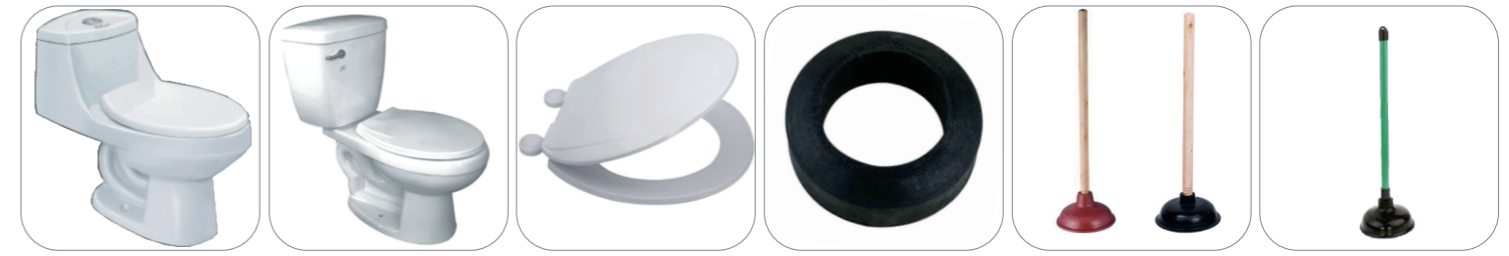

MT 0173 MT 0174 MT 0165 F-2428 F-2429 F-2430



MT 0161



F-2516 F1/2"xF1/2"

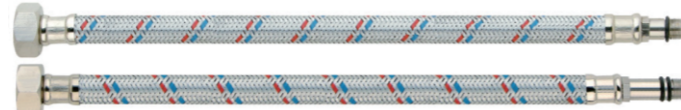

F-2522 F1/2"xM10 SHORT
F-2523 F1/2"xM10 LONG



F-2509



F-2503 F1/2"xM1/2"



F-2517 F1/2"xF1/2"



F-2524 F1/2"xM10 SHORT
F-2525 F1/2"xM10 LONG



F-2501 F3/8"xF1/2"



F-2504 F1/2"xF7/8"



F-2508 F3/8"xF1/2"



F-2510



F-2502 F3/8"xF7/8"



F-2505 F1/2"xF1/2"



F-2518 F3/8"xF1/2"



F-2526



F-2519 F1/2"xF7/8"



F-2527 F1/2"xM1/2"



F-2513



F-2514



F-2515



F-2520 F1/2"xF7/8"



F-2512 F1/2"xM1/2"



F-2521 F3/8"xF7/8"



F-2528



F-2530



F-2531



F-2511 F3/8"xF7/8"



F-2529



L-3838



L-4848



L-5348B



L-8348B



L-8356



L-6248



L-6356



L-8050GL



L-8050GR



L-7548L



L-7548R



L-8052L



L-8052R



L-8050CL



L-8050CR



L-8050FL



L-8050FR



L-15050



L-10050CL



L-10050CR



L-8050EL



L-8050ER



L-10050EL



L-10050ER

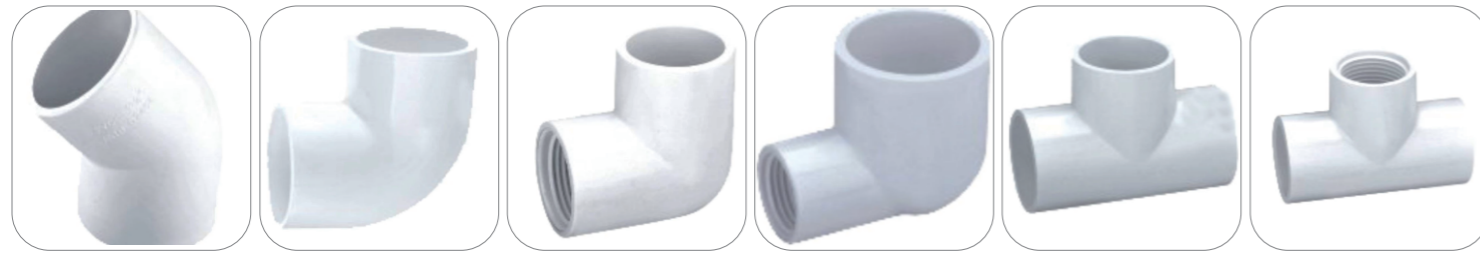

MT 0052 MT 0050 MT 0053 MT 0058 MT 0048 MT 0057

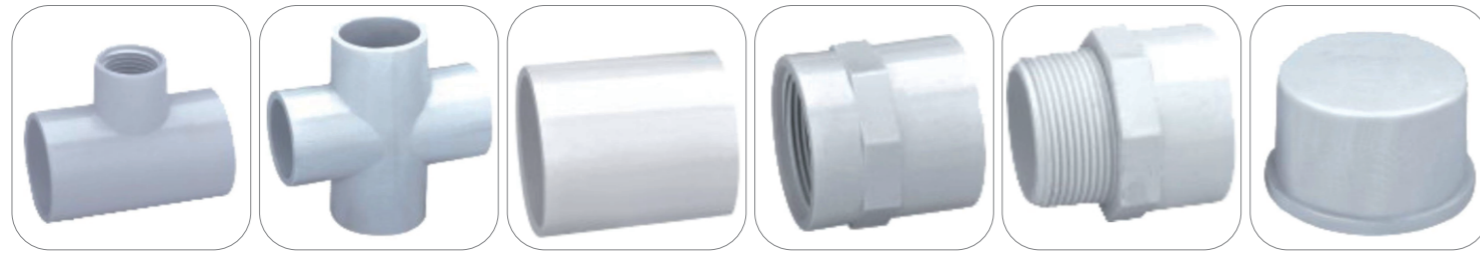

MT 0060 MT 0056 MT 0047 MT 0055 MT 0059 MT 0051

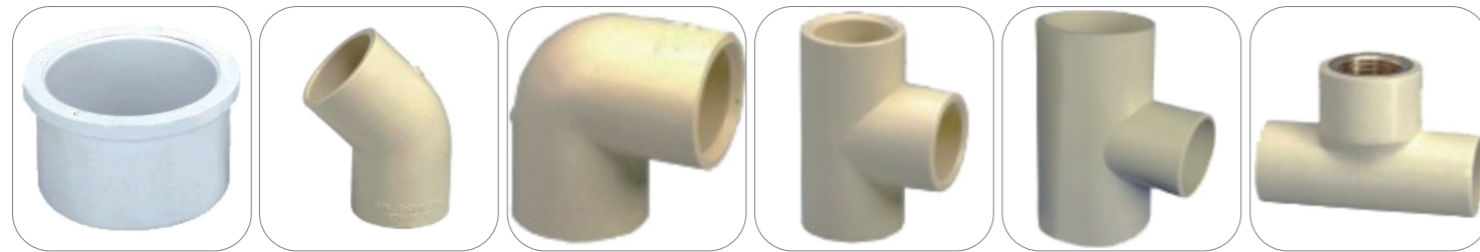

MT 0054 900 TM MT 0083 MT 0082 MT 0072 MT 0069



MT 0078 MT 0074 MT 0073 MT 0071 MT 0068 MT 0081

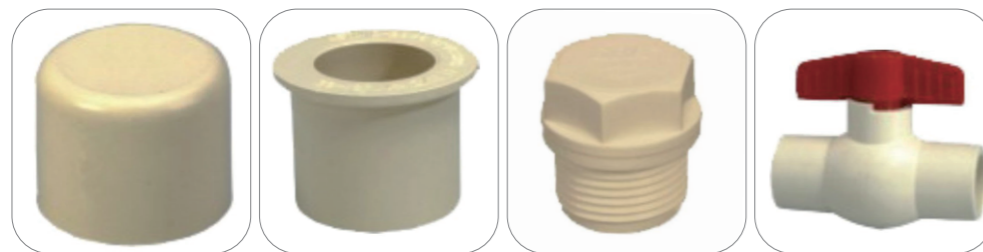

MT 0080 MT 0075 MT 0076 MT 0077



F-2801 MT 1001 MT 1003 F-2804 MT 1002 F-2806



F-2808 F-2809 MT 1009 MT 1013 MT 1015 MT 1014



F-2816 F-2810 F-2812 F-2813 F-2825 F-2826



F-2827 F-2817 F-2828 F-2829 F-2821 F-2830



F-2822 F-2819 F-2820 F-2818 F-2831 F-2832



MT 1248 MT 1249 MT 1250 MT 1246 MT 1245 MT 1243



MT 1240 MT 1240A MT 1329 MT 1339 MT 1335 MT 1340



MT 0340 MT 0348 MT 0342 MT 0343 MT 0345 MT 0345B



MT 0341 MT 0349 MT 0354 MT 0353 MT 0334 MT 0361



F-2614 F-2613 MT 0365 MT 0366 MT 0344 MT 0359



F-2833 F-2834 F-2835 F-2836 F-2837 F-2838



F-2819 F-2840 105mm F-2841 117mm F-2842 140mm MT 0347 CENTRO MT 0351



MT 0352 MT 0346 LATERAL F-2843 F-2844 F-2845 MT 0362

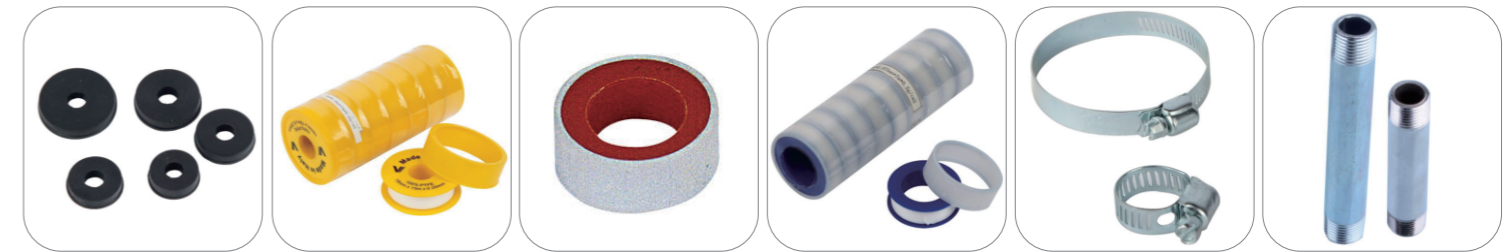

MT 0363 F-2610 F-2611 F-2612 MT 0653 MT 0288

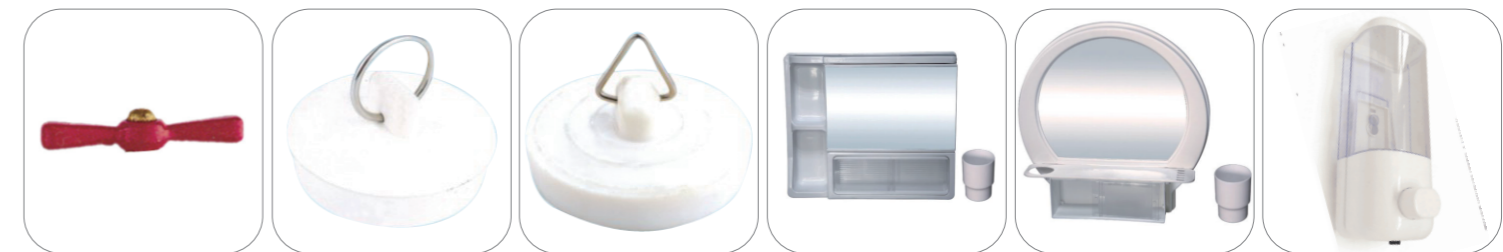

F-2846 F-1909 F-1910 F-2847 F-2848 F-2849



Jx6001



Jx6002



Jx6003



Jx6004



Jx6009



Jx6010



Jx6011



Jx6012



Jx6005



Jx6006



Jx6007



Jx6008



Jx6013



Jx6014



Jx6015



Jx6016



Jx6017



Jx6018



Jx6019



Jx6020



Jx6025



Jx6026



Jx6021



Jx6022



Jx6023



Jx6024